

Icon-Line

🇩🇰 Made in Denmark



HETA's range of stoves, Icon-Line, which includes the models Eclipse, Eclipse XL and Moderna, is a stylish and exclusive product series. The stoves in the Icon-Line series are available in a timeless, stylish black or gray color. You can choose between steel and soapstone, and they are easy to operate with the air regulation function at the front of the stove. All models in the Icon-Line series come with Heta's combustion technique, Clean Burn, which effectively and environmentally friendly ensures a clean combustion and exquisite view of the flames.



Moderna



Moderna has a stylish glass front and can be chosen both with and without side glass and bottom door. The wood-burning stove is available in a black and gray color, so that it appears as a unifying, cozy and warm focal point in the living room. It is possible to choose between steel and soapstone in both variants.

It is possible to purchase Heta's HAC 2.0 technology for Moderna, which is easy to control through Heta's app for Android/iOS via Bluetooth. There is an indicator attached to the oven which, using color codes (red, yellow and green) draws attention to if there is a need for new ignition, or if too much firewood is loaded.

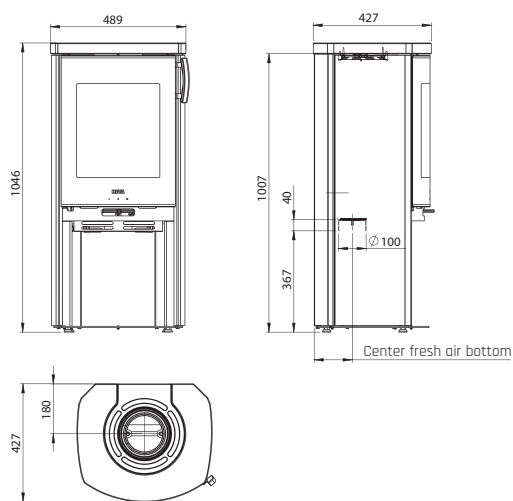
The stove's door is equipped with a door sensor that detects when new firewood has been added.

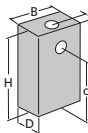
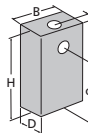

Technical info Moderna

Oven model	Moderna	Moderna Sideglas	Options
mm	 A: 180 B: 489 C: 889 D: 427 H: 1046	 A: 180 B: 489 C: 889 D: 427 H: 1046	 Soapstone  Paint black/grey
Floor to top outlet mm	1007	1007	
Energy efficiency class	A	A	
Nominal kW	6,2	6,2	
Weight kg	110 → 159	109 → 146	
Indføringsmængde kg	1,6	1,6	
Combustion chamber width mm	330	330	
Distance to flammable materials			
At the sides mm	400	450	
Behind stove mm	160/60	160/60	
Distance to furniture mm	1100	900	
Efficiency	79	79	
Ecodesign requirement of 75%			
Dust measurement	13	13	
Ecodesign requirement of 40 Mg/Nm ³ 13% O ₂			



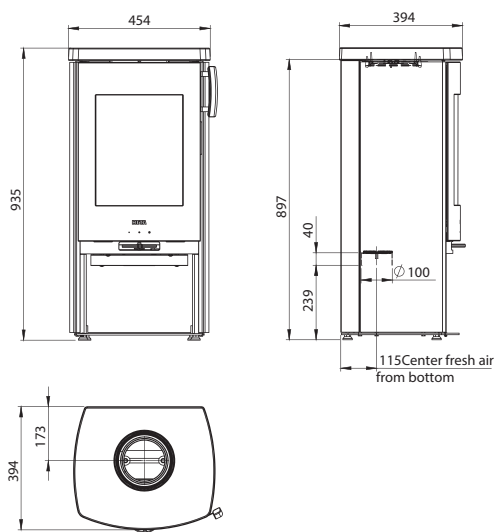

Eclipse

Eclipse is a beautiful, powerful wood-burning stove that is perfect for smaller rooms, as a cozy gathering point for family and friends. It is possible to choose between a black and gray color and steel or soapstone, so Eclipse an extension of your interior decor. With a very small distance behind the stove to combustibile material, the Eclipse is perfect for holiday homes. Eclipse can be selected both with and without side glass.

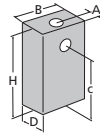
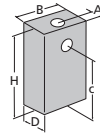

Technical info Eclipse

Oven model	Eclipse	Eclipse Sideglas	Options
mm	 A: 173 B: 454 C: 785 D: 394 H: 935	 A: 173 B: 454 C: 785 D: 394 H: 935	 Soapstone  Paint black/grey
Floor to top outlet mm	898	898	
Energy efficiency class	A	A	
Nominal kW	5,4	5,4	
Weight kg	91 → 135	91 → 140	
Indføringsmængde kg	1,22	1,22	
Combustion chamber width mm	289	289	
Distance to flammable materials			
At the sides mm	350	400	
Behind stove mm	100/50	100/50	
Distance to furniture mm	1000	900	
Efficiency			
Ecodesign requirement of 75%	79	79	
Dust measurement			
Ecodesign requirement of 40 Mg/Nm ³ 13% O ₂	14	14	





Eclipse XL

With the Eclipse XL, you get a modern wood-burning stove, which with its large combustion chamber is an obvious solution for larger rooms or in general homes with many square meters that need to be heated.

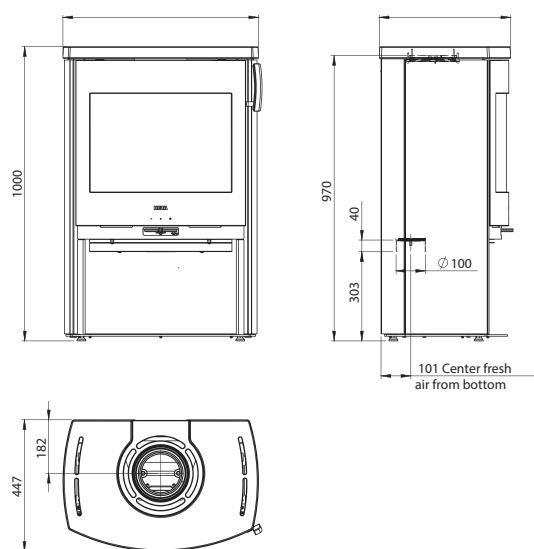
The wood-burning stove appears elegant and stylish as an integrated part of any home and is easy to operate.

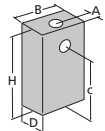

Technical info Eclipse XL

Oven model	Eclipse XL	Options
mm	 <p>A: 182 B: 665 C: 848 D: 447 H: 1000</p>	 Soapstone  Paint black/grey
Floor to top outlet mm	970	
Energy efficiency class	A+	
Nominal kW	7,1	
Weight kg	143 → 194	
Indføringsmængde kg	1,75	
Combustion chamber width mm	472	
Distance to flammable materials At the sides mm Behind stove mm	400 125/75	
Distance to furniture mm	1200	
Efficiency Ecodesign requirement of 75%	81	
Dust measurement Ecodesign requirement of 40 Mg/Nm³ 13% O₂	25	



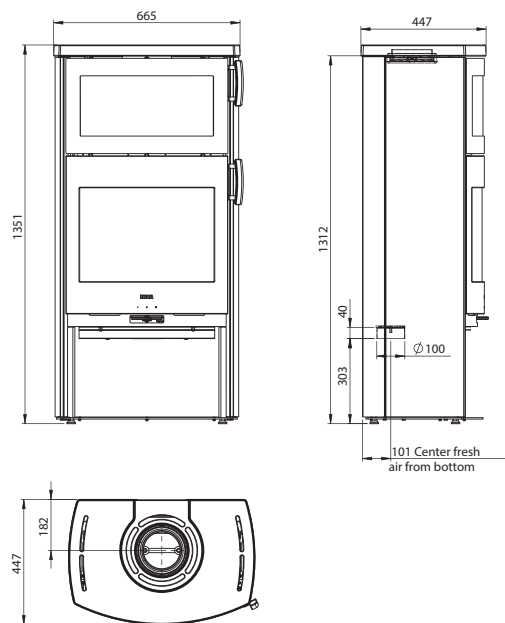

Eclipse XL-B

HETA's Eclipse XL-B makes sure to keep the home or summer house warm with its large firebox, so that warmth and coziness come into every nook and cranny. The wood-burning stove is equipped with a large baking oven, which is used for all imaginable culinary explorations. The entire Eclipse XL series can be equipped with a soapstone top or complete soapstone.

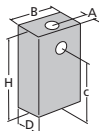

Technical info Eclipse XL-B

Oven model	Eclipse XL-B	Options
mm	 <p>A: 182 B: 665 C: 848/1171 D: 447 H: 1351</p>	 Soapstone  Paint black/grey
Floor to top outlet mm	1312	
Energy efficiency class	A+	
Nominal kW	7,1	
Weight kg	186 → 253	
Indføringsmængde kg	1,75	
Combustion chamber width mm	472	
Distance to flammable materials		
At the sides mm	400	
Behind stove mm	125/75	
Distance to furniture mm	1200	
Efficiency	81	
Ecodesign requirement of 75%		
Dust measurement	25	
Ecodesign requirement of 40 Mg/Nm ³ 13% O ₂		





Eclipse XL-S

With HETA's model, the Eclipse XL-S, no design has been spared or comfort. With its large combustion chamber, the Eclipse XL-S provides for warmth in all corners of the home or cottage, so the fun can quickly set in.

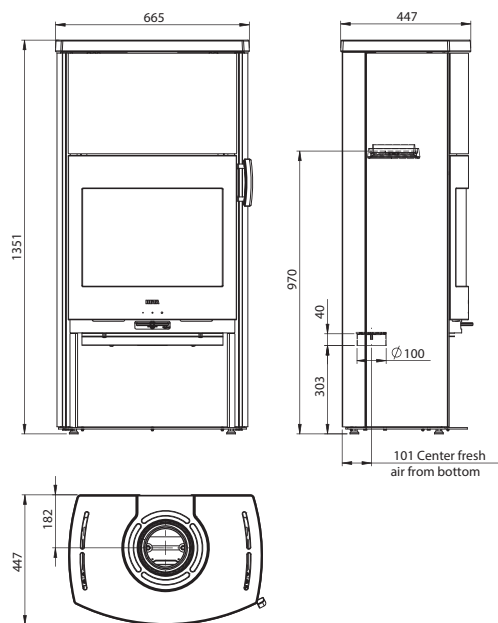
If you want to accumulate even more heat, so that the next morning there is still a hot stove, you can buy an additional 89 kg. accumulation stone that is hidden on top of the stove behind the steel front. The wood-burning stove is available both with and without the lower door.

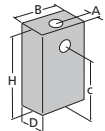

Technical info Eclipse XL-B

Oven model	Eclipse XL-B	Options
mm	 <p>A: 182 B: 665 C: 848/1171 D: 447 H: 1351</p>	 Soapstone  Paint black/grey
Floor to top outlet mm	970	
Energy efficiency class	A+	
Nominal kW	7,1	
Weight kg	257 → 326	
Indføringsmængde kg	1,75	
Combustion chamber width mm	472	
Distance to flammable materials		
At the sides mm	400	
Behind stove mm	75/125	
Distance to furniture mm	1200	
Efficiency	81	
Ecodesign requirement of 75%		
Dust measurement	25	
Ecodesign requirement of 40 Mg/Nm ³ 13% O ₂		



Selected variants



Moderna
Side glass
Soapstone



Moderna
Side glass
Bottom door



Moderna
Bottom door



Eclipse
Side glass
Soapstone



Eclipse
Side glass
Bottom door



Eclipse
Soapstone



Eclipse
Bottom door



Eclipse XL
Soapstone



Eclipse XL
Bottom door



Eclipse XL-B
Soapstone



Eclipse XL-B
Bottom door



Eclipse XL-S
Bottom door



03.2023 Print: strøndbygaard.dk Photo: HETA



Jupitervej 22 | DK-7620 Lemvig | heta.dk

 Made in Denmark